

ELEVATION A

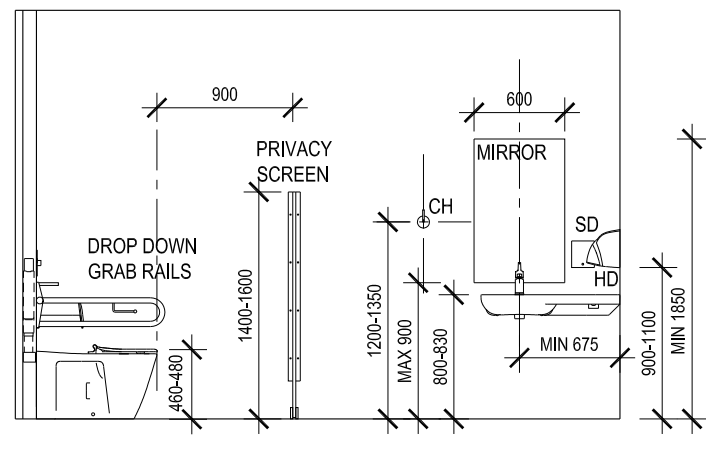

ELEVATION B

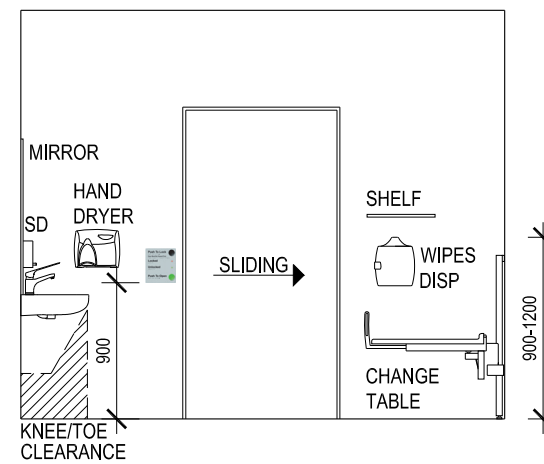

ELEVATION C

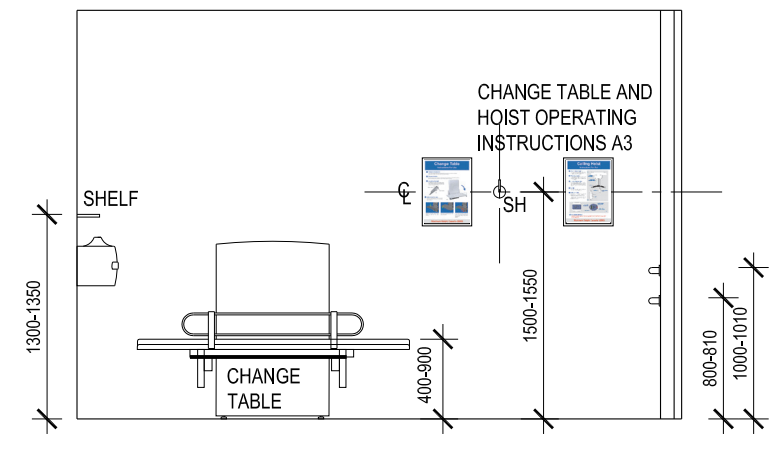

ELEVATION D

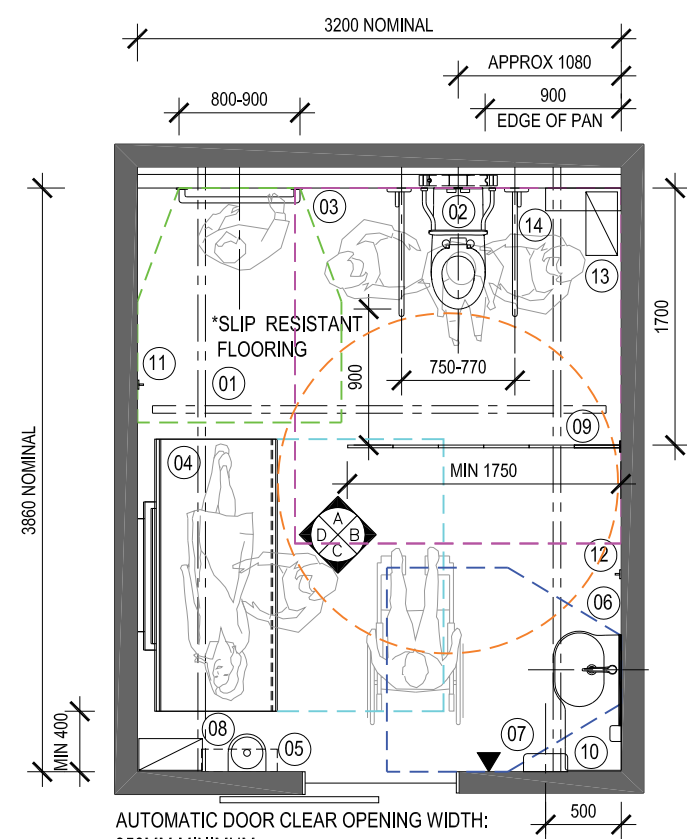

AUTOMATIC DOOR CLEAR OPENING WIDTH:
950MM MINIMUM.
(1100MM MIN. AT BEACH OR LAKE LOCATIONS)

DESIGN 1A
WITHOUT SHOWER RECTANGULAR

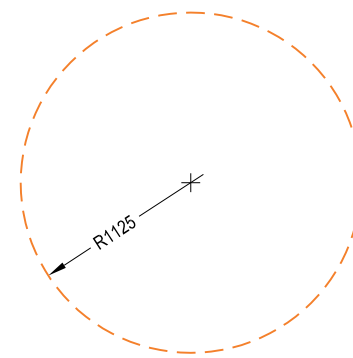

TURNING
CIRCULATION SPACES

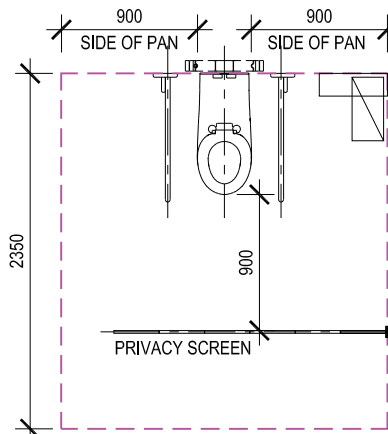

PAN

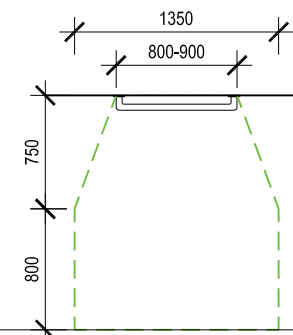

CHANGING RAILS

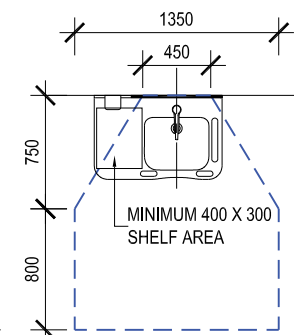

BASIN

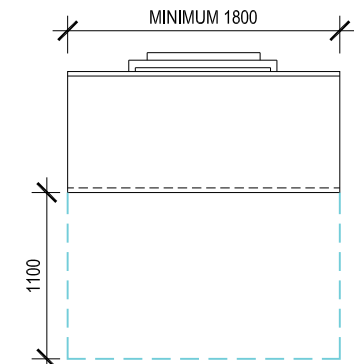

CHANGE TABLE

- 01 ROOM COVERAGE HOIST
- 02 ACCESSIBLE WC INCL BACKREST AND DROP DOWN GRABRAILS
- 03 TWO 800-900MM LONG HORIZONTAL CHANGING RAILS AT 800MM AND 1000MM ABOVE FLOOR LEVEL
- 04 ADJUSTABLE HEIGHT CHANGE TABLE, 1800MM LONG WITH SIDE SAFETY RAIL
- 05 CHANGE TABLE WIPE DISPENSER WITH 450 x 150MM SHELF OVER
- 06 HAND BASIN WITH INTEGRATED SHELF
- 07 HAND DRYER
- 08 INCONTINENCE PAD DISPOSAL BIN
- 09 RETRACTABLE PRIVACY SCREEN 1900MM LONG
- 10 SOAP DISPENSER
- 11 LARGE SLING HOOK
- 12 CLOTHES HOOK
- 13 SANITARY PRODUCT DISPOSAL BIN
- 14 450 X 150MM SHELF
- ▼ AUTOMATIC DOOR CONTROL

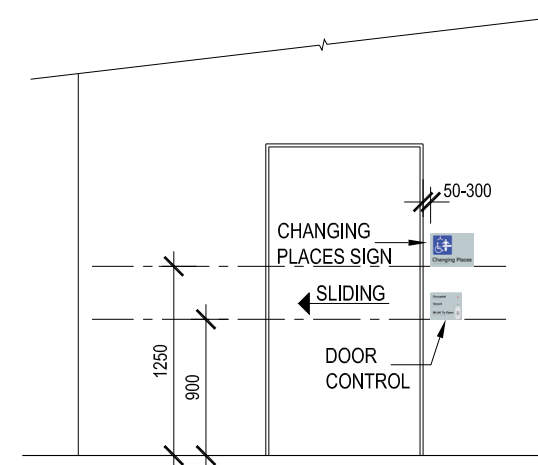

EXTERNAL DOOR

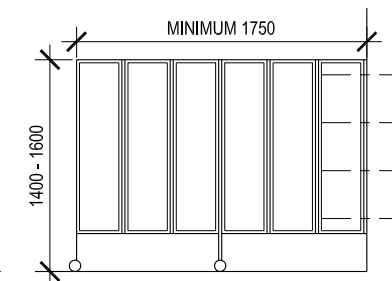

PRIVACY SCREEN

